

RESEARCH AND EVALUATION OF THE INTENSITY PARAMETERS OF ELECTROMAGNETIC FIELDS PRODUCED BY MOBILE COMMUNICATION ANTENNAS

Pranas Baltrėnas¹, Raimondas Buckus², Saulius Vasarevičius³

Department of Environmental Protection, Vilnius Gediminas Technical University,
Saulėtekio al. 11, LT-10223 Vilnius, Lithuania

E-mails: ¹pranas.baltrenas@vgtu.lt; ²raimisbc@gmail.com (corresponding author);
³saulius.vasarevicius@vgtu.lt

Submitted 05 Sep. 2012; accepted 08 Oct. 2012

Abstract. As the network of cellular mobile phones has recently expanded and in particular after the digital GSM 900/1800/2100 systems have been introduced, the potential effect on human health of electromagnetic radiation from the base stations of these systems has become of great concern to European countries. There have been requests made in some countries for areas free from mobile phones in which installation of base stations would not be permitted and for considerable reduction of the maximum authorised exposure or other restrictions. The European Commission's Recommendation adopted on 12 July 1999 requires that the maximum field strength for electromagnetic radiation (0–300 GHz) is established and that information about population's exposure to EMF and the measures taken to reduce it is provided. The article presents and analyses EMFs produced by mobile communication antennas in a residential area. Measurements of the electric strength, magnetic strength and EMF power density were performed and compared to the established hygiene norms. Tests were conducted in the near- and far-field of the antenna, on residential premises located directly in front of the antenna within its main radiation lobe. In addition, there were performed measurements of electromagnetic fields produced by mobile communication in rural areas.

Keywords: electric field strength, magnetic field strength, EMF power density, mobile communication antenna.

1. Introduction

In recent decades the questions of electromagnetic field measurement and evaluation, the compliance of EMF intensity parameters with hygiene norms, and the setting of sanitary and limit construction zones have become of paramount importance worldwide (Alanko *et al.* 2008).

EMF intensity parameters are measured for a diversity of reasons:

a) radio engineering installations are measured in order to evaluate electromagnetic fields produced by them. Such measurements are done in accordance with hygiene norms, standards or other regulatory documents;

b) EMF measurements are carried out to the orders of the general public, authorities or suppliers. The measurements are conducted in a particular place (for example, in a room, balcony, playground, etc) by identifying EMF sources;

c) comparative measurements of electromagnetic fields. EMFs produced by a radio engineering facility in one location are compared against those in another one;

d) scientific EMF studies. These are long-term monitoring measurements covering measurement places that are most frequented by people and the obtained data are used for epidemiological studies (Bergqvist *et al.* 2001).

In performing field measurements of EMFs, the key task is to appropriately identify measurement places (Miclaus, Bechet 2007). An important stage is to evaluate

where the values of EMF intensity parameters will be the highest (Baltrėnas, Buckus 2011). This can be done using orthophotos, various maps, modelling programs or by measuring the areas concerned with EMF meters and identifying and selecting zones with the highest electromagnetic field values (Baltrėnas *et al.* 2011).

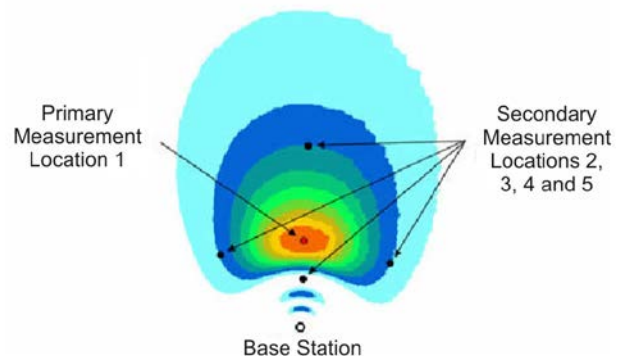

Fig. 1. Electromagnetic field measurement chart (view from the top)

The potential measurement locality should be open with the antenna of a radio engineering installation being in immediate visibility (Alanko, Hietainen 2007).

Once the main EMF measurement point has been selected, another four points in close proximity to the main

one need to be identified. As Fig. 1 shows, the main point should represent the highest EMF values, whereas the others – lower values than the main point. In practical measurements such a symmetrical measurement chart is difficult to realise (Dolan, Rowley 2009).

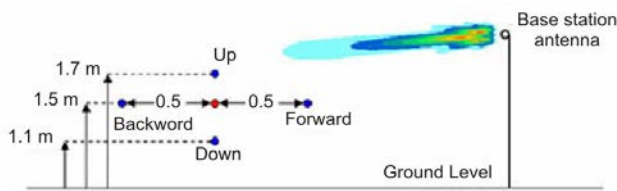

Fig. 2. Electromagnetic field measurement chart (lateral view)

In order to correctly evaluate the electromagnetic field, measurements are to be taken at a height of around 1.1, 1.5 and 1.7 m above the ground (Fig. 2). It is recommended that measurements should be made in at least three points, but this number may increase up to six depending on the locality and accuracy. The arithmetic mean of these measurements is considered to be the result (Bernardi *et al.* 2000). The result of EMF field measurements depends on the distance to a radio engineering source (Baltrėnas, Buckus 2009). With the distance from EMF source increasing the EMF is described by three fields (Fig. 3).

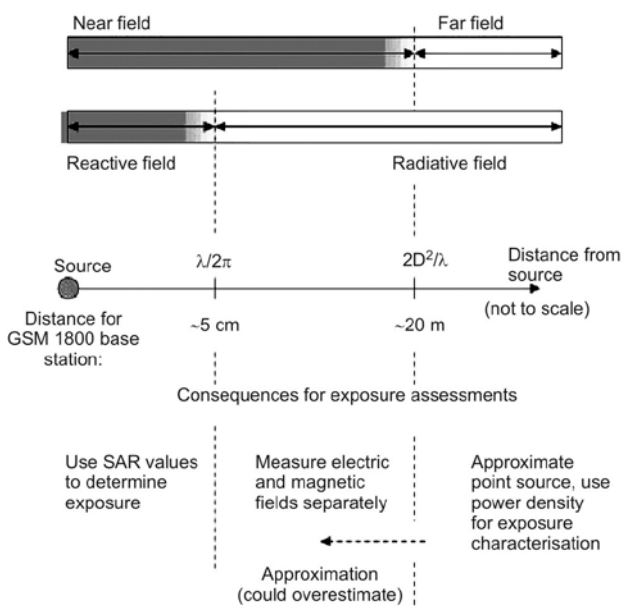

Fig. 3. Illustration of three zones: reactive near field, radiative near field and (radiative) far field, and its consequences for exposure assessments. D = largest dimension of source. λ = wavelength (17 cm for 1800 MHz). SAR = Specific Absorption Rate

In the close vicinity of antenna, measurements are more difficult because of the so-called near field conditions. In the radiative near field, the relationships between the electric and the magnetic fields are much more complex, and separate evaluation of them should be performed. Measuring the electric fields and using the far-field assumptions (above) in this zone would often lead to overestimating the exposure. Calculations by the NRPB has indicated that using the far-field approximation

(above) at e.g. 10 m from a large base station antenna would overestimate the exposure by a few percent, while at 1 m the overestimate would be some 10–20 times (Bergqvist *et al.* 2001).

Propagation of electromagnetic fields is largely dependent on the dimensions of a radio engineering installation (antenna) and wavelength (Olivier, Martens 2005). For example, the far-field for elementary antennas starts at distances equal to wavelength parts, whereas for large sharp-directional antennas – only at distances equalling thousands of wavelengths (Mangoud *et al.* 2000). It is not difficult to describe electromagnetic wave propagation within the far-field, but the near-field is characteristic of a complicated wave composition and therefore interactions of electromagnetic waves and biological systems are complicated in this field both theoretically and experimentally (Damian, Foşalău 2011). Theoretically, field distribution can be calculated using parameter $L_z = 2D^2/\lambda$, where D – dimensions of antenna's active (radiating) part, and λ – wavelength (17 cm). L_z denotes the transitional field range. For example parameter L_z for 1.5 m high antenna emitting electromagnetic waves of 1.8 GHz wavelength is 26 m. Thus, distances below 26 m are governed by the near-field conditions, while longer ones – by the far-field conditions. In the near-field the strength of electric field and the strength of magnetic field are not perpendicular to each other and it is difficult to relate them with a propagating electromagnetic wave (Akbal *et al.* 2012). With proximity to the source these fields become less similar to a propagating wave, and they are often referred to as reactive fields or vanishing modes. In the near-area, fields change very fast with distance (Lin 2002).

In the far-field it is enough to measure the strength of either an electric or magnetic field only and calculate the EMF power density according to formulas $S = E^2/377$ or $S = 377 H^2$ where E is the electric field in V/m, H is the magnetic field in A/m and P is the power density in W/m^2 . In the far-field where the electromagnetic field has taken the shape of a wave, the dependence on simultaneous process occurring in the antenna does not exist any longer (Cicchetti *et al.* 2003).

In order to identify EML propagation limits and adjustment areas in a specific locality, it is necessary to appropriately select the main parameters of antenna spatial distribution: height of the antenna's geometric centre, direction of the most intensive radiation (azimuth) and the required downtilting of directional pattern on the vertical and horizontal plane. However, evaluation of the main components of the physical environment (relief, buildings, etc.) restricting electromagnetic radiation propagation is problematic. Furthermore, it is difficult to estimate EMF values on building facades and calculate the total propagation values of several antennas (Poljak, Kovac 2004).

For the purpose of identifying and adjusting EMF propagation limits antennas are being designed of the structure that allows for electrical and mechanical downtilting of their directional pattern on the vertical and horizontal plane, thus addressing EMF identification problems.

Distribution of electromagnetic fields produced by antennas highly depends on the electric and mechanical downtilting angles of antenna's directional pattern. Appropriately selected antenna's directional patterns on the vertical and horizontal plane at different angles of electric downtilting ensure that the measured values of EMF intensity generated by a real antenna at any point in space will not exceed the design values and will meet the requirements of hygiene norms regulating sources of non-ionizing radiation. Disregard of antenna's electric and mechanical downtilting angles would lead to inaccuracies in EMF propagation limits (Pocius 2005).

When expanding and adjusting propagation limits the mobile cellular network developer uses standard directional patterns presented in catalogues and in the electronic format. All methodologies used to determine EMF propagation limits and adjustment areas for antenna installations in the environment are based on the worst-case scenarios; for example, precaution limits are used due to the variations in antenna directional patterns, potential changes in the properties of the ground surface caused by climatic conditions, etc. (Loughran *et al.* 2005).

Where it is determined that the permissible level of EMF intensity parameters has been exceeded, the operator must promptly discontinue operating the radio engineering installation or reduce the level of EMF intensity to the set values (Santini *et al.* 2003).

Measurements also require to have in place procedures for calculating uncertainties of results by assessing the instrument's class of accuracy, isotropicity, linearity, ambient temperature and relative humidity, the effect of human body, etc. (Henderson, Bangay 2006).

Aim of the work: to evaluate the levels of intensity parameters of electromagnetic fields produced by mobile communication antennas in the environment.

2. Methods

Characterisation of the parameters of electromagnetic radiation from mobile communication in the near-field of the antenna covers measurements of electric and magnetic strengths. In the far-field the EMF power density is measured. We evaluated measurement's points by measuring the areas concerned with EMF meter and presented zones with the highest electromagnetic field values. The influence of the other base stations in the vicinity is very small (about 1%), so they are not defined.

Tests on the mobile communication antenna's electric field strength and magnetic field strength were carried out in Šeškinės street 2 street where mobile communication antenna KATHREIN 80010292 is mounted on the roof. Antenna's coordinates: 54° 42' 45.78"N and 25° 15' 0.56"E (WGS coordinate system). The antenna is directed northwest. Antenna's operating frequency is 806–960/1710–2180/1710–2180 MHz, effective radiated power (ERP takes into consideration transmitter power output, transmission line attenuation, RF connector insertion losses, and antenna's directivity) is 350 W, coverage area on the horizontal plane – 65°/65°/65°, coverage area on the vertical plane – 7.5°/7.6°/6.8°, mechanical downtilt – 0°/0°/0°, electric downtilt – 2°–10°/0°–10°/0°–10°, gain –

17.5/17.5/17 dBi. The antenna sits on a 12 m high building, it is 2.6 m long and its pole is 2.0 m high.

Measurements were performed atop the roof in front of the mobile communication antenna according to the chart given in Figure 4.

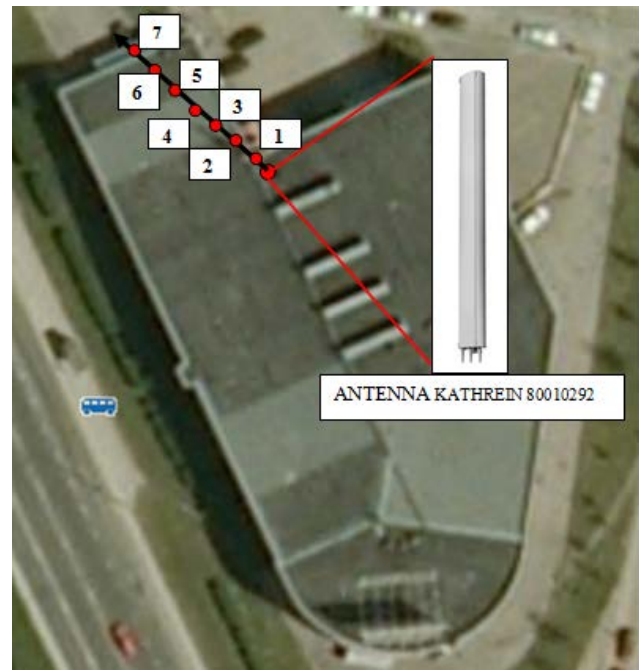

Fig. 4. Measurement chart of mobile communication antenna's electric strength and magnetic strength atop the roof

Measurement point 1 is at 1 m distance, measurement point 2 – at 5 m distance, measurement point 3 – at 10 m distance, measurement point 4 – at 15 m distance, measurement point 5 – at 20 m distance, measurement point 6 – at 25 m distance, 7 measurement point – at 30 m distance from the antenna's vertical axis. All measurement points are identical, only a distance to the antenna differs. Tests were carried out at a height of 1.5 m above the building roof on which the antenna is mounted. The arithmetic mean of 3 values is deemed to be the measurement result. The duration of one measurement is 6 minutes.

Ground measurements of the EMF power density were conducted in front of the mobile communication antenna KATHREIN 80010292 (antenna's technical parameters and address are the same) in accordance with the chart presented in Figs. 5 and 6. Antenna's coordinates: 54° 42' 45.78"N and 25° 15' 0.56"E (WGS coordinate system). Electromagnetic radiation measurement points: 1 – beside the building, azimuth 330° (measurement point is outside antenna's direct visibility area), distance of 30 m; 2 – in the middle of the road within antenna's direct visibility, azimuth 330°, distance of 40 m; 3 – on the edge of the road within antenna's direct visibility, azimuth 330°, distance of 50 m; 4 – on the road (uphill) within antenna's direct visibility, azimuth 330°, distance of 60 m; 5 – on a hill in the meadow, within antenna's direct visibility, azimuth 330°, distance of 70 m; 6 – in the meadow (downhill), within antenna's direct visibility, azimuth 330°, distance of 80 m; 7 – on the sidewalk, within antenna's direct visibility, azimuth 330°, distance

of 90 m; 8 – in the middle of asphalt-paved road, within antenna’s direct visibility, azimuth 330°, distance of 100 m. Another two points were selected: point 1 – at 40 m distance, and point 2 – 70 m distance and the EMF power density at these points was measured throughout 24 hours a day (at 1 h interval). The tests were performed at a height of 1.5 m above the ground. The arithmetic mean of 3 values is considered as the measurement result. The duration of one measurement is 6 minutes.

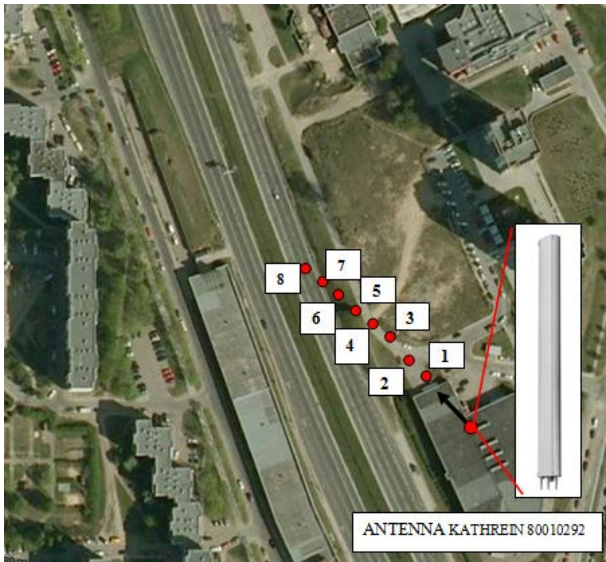

Fig. 5. Mobile communication antenna EMF power density measurement chart on the ground in the area of antenna’s direct visibility

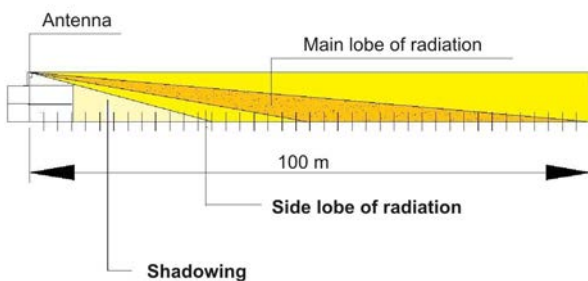

Fig. 6. Mobile communication antenna EMF power density distribution on the ground according to vertical radiation

EMF power density measurements on the roof in front of mobile communication antenna KATHREIN 80010292 (54° 40' 24.81"N and 25° 16' 38.25"E) were performed in Kauno street 5 according to the chart given in Fig. 7. Antenna’s operating frequency is 806–960/1710–2180/1710–2180 MHz, effective radiated power is 525 W, coverage area on the horizontal plane – 65°/65°/65°, coverage area on the vertical plane – 7.5°/7.6°/6.8°, mechanical downtilt 0°/0°/0°, electric downtilt 2°–10°/0°–10°/0°–10°, and gain 17.5/17.5/17 dBi. The antenna is mounted on a 20 m high building and is 2.6 m long with the pole height of 1.0 m. All electromagnetic radiation measurement points are on the building roof: 1 – azimuth 320°, distance of 35 m; 2 – azimuth 335°, distance of 40 m; 3 – azimuth 335°, distance of 45 m; 4 – azimuth 340°, distance of 50 m; 5 – azimuth 340°, distance of 55 m; 6 – azimuth 340°, distance of 60 m; 7 – azimuth 340°, distance of

65 m; 8 – azimuth 340°, distance of 70 m. All points are within antenna’s direct visibility area. The arithmetic mean of 3 values is deemed to be the test result. The duration of one measurement is 6 minutes.

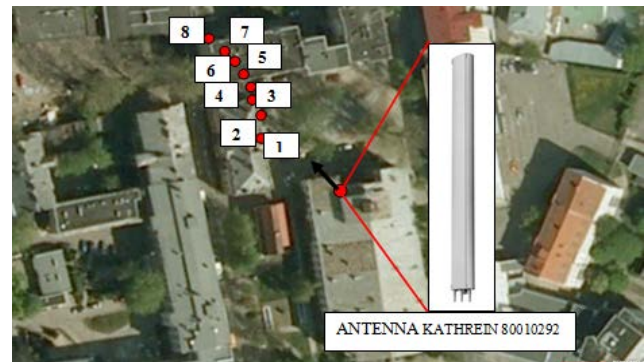

Fig. 7. Mobile communication antenna EMF power density measurement chart on the roof within antenna’s direct visibility area

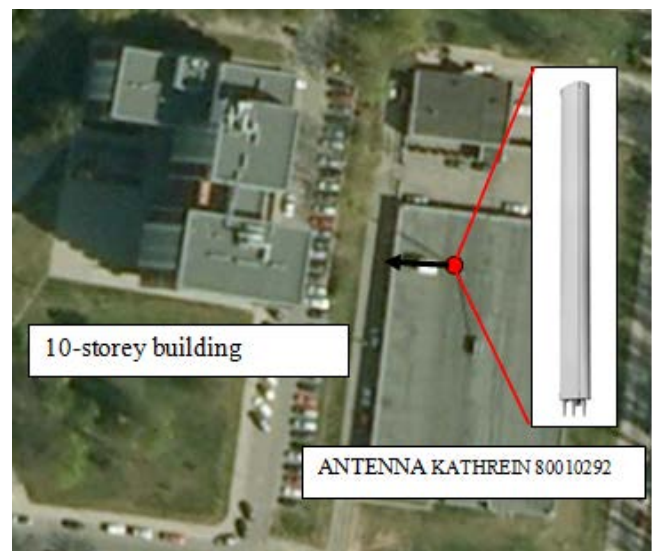

Fig. 8. Mobile communication antenna EMF power density measurement chart on residential premises within antenna’s direct visibility area

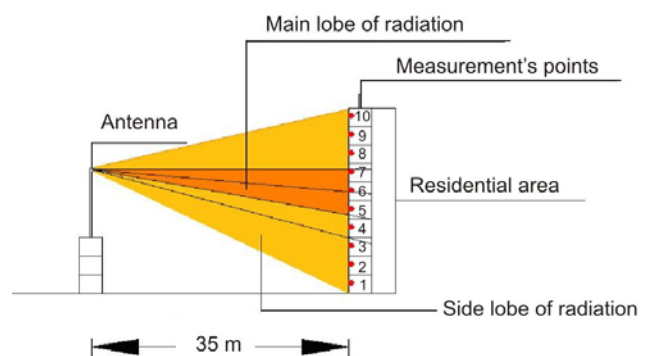

Fig. 9. Mobile communication antenna EMF power density distribution in residential area according to vertical radiation

According to the measurement chart given in Figs. 8 and 9 the EMF power density was measured for a 10-storey building (Rugij street 4) with mobile communication antenna KATHREIN 80010292 built in front of the

building. Antenna's operating frequency is 806–960/1710–2180/1710–2180 MHz, effective radiated power is 175 W, coverage area on the horizontal plane – 65°/65°/65°, coverage area on the vertical plane – 7.5°/7.6°/6.8°, mechanical downtilting is 0°/0°/0°, electric downtilting is 2°–10°/0°–10°/0°–10°, and gain – 17.5/17.5/17 dBi. The antenna is mounted on a 10 m high building. Antenna's pole is 8 m high, and the antenna is 2 m long. Electromagnetic radiation measurement points (height above the ground in balcony): point 1 on floor 1 – 1.5 m high, point 2 on floor 2 – 4.5 m high, point 3 on floor 3 – 7.5 m high, point 4 on floor 4 – 10.5 m high, point 5 on floor 5 – 13.5 m high, point 6 on floor 6 – 16.5 m high, point 7 on floor 7 – 19.5 m high, point 8 on floor 8 – 22.5 m high, point 9 on floor 9 – 25.5 m high, point 10 on floor 10 – 28.5 m high. The azimuth of all measurement points is 270°, coordinates 54° 44' 31.15"N and 25° 16' 15.56"E. The height of the building is 30 m. The distance between the building and antenna is 35 m. Also measurements were performed at a height of 0.5 m, 1 m and 1.7 m above the floor in the middle of the every room and at a height of 0.5 m, 1 m and 1.7 m above the floor in front of window (the distance between window and measuring point – 1 m). The arithmetic mean of 3 values is considered as the test result. The duration of one measurement is 6 minutes.

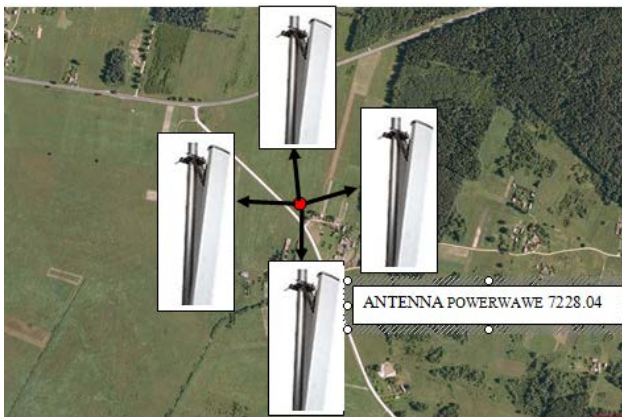

Fig. 10. Mobile communication antenna EMF power density measurement chart in rural area

According to the chart in Figs. 10 and 11 EMF power density measurements were performed in Lavoriškės (rural area) with 4 mobile communication antennas, POWERWAVE 7228.04, built in the middle of the field (Fig. 8). The antennas are directed northward, eastward, westward and southward. Antenna operating frequency is 870–960 MHz, effective radiated power – 660 W, coverage area on the horizontal plane – 65°/65°/65°/65°, coverage area on the vertical plane – 6.5°/6.5°/6.5°/6.5°, mechanical downtilting – 0/0/4/1° electrical downtilting – 0/0/0/0°, and gain – 18/15.9 dBi. The antenna pole is 70 m high, and the antenna is 2.6 m long.

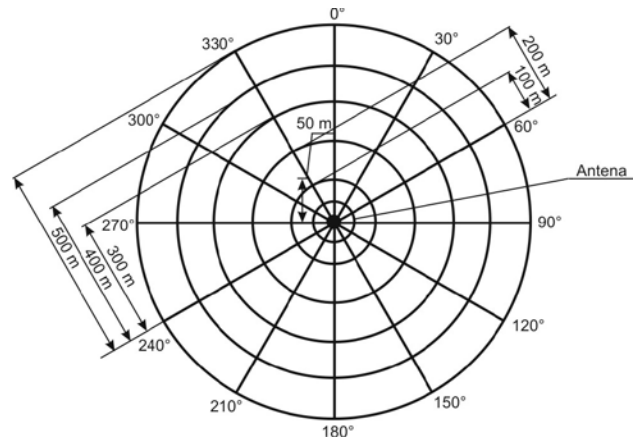

Fig. 11. EMF power density measurement chart for mobile communication antennas POWERWAVE

Electromagnetic radiation measurement points at 50 m distance: meadow, azimuth 0°; meadow, azimuth 30°; meadow, azimuth 60°; meadow, azimuth 90°; beside the building, azimuth 120°; under the trees, azimuth 150°; road, azimuth 180°; meadow, azimuth 210°; meadow, azimuth 240°; meadow, azimuth 270°; road, azimuth 300°; meadow, azimuth 330°. Electromagnetic radiation measurement points at 100 m distance: meadow, azimuth 0°; meadow, azimuth 30°; meadow, azimuth 60°; meadow, azimuth 90°; beside the outhouse, azimuth 120°; yard, azimuth 150°; road, azimuth 180°; meadow, azimuth 210°; meadow, azimuth 240°; meadow, azimuth 270°; meadow, azimuth 300°; meadow, azimuth 330°. Electromagnetic radiation measurement points at 200 m distance: meadow, azimuth 0°; meadow, azimuth 30°; meadow, azimuth 60°; meadow, azimuth 90°; under the tree, azimuth 120°; beside the building, azimuth 150°; meadow, azimuth 180°; beside the outhouse, azimuth 210°; meadow, azimuth 240°; meadow, azimuth 270°; meadow, azimuth 300°; meadow, azimuth 330°. Electromagnetic radiation measurement points at 300 m distance: meadow, azimuth 0°; meadow, azimuth 30°; meadow, azimuth 60°; forest, azimuth 90°; forest, azimuth 120°; by the outhouse, azimuth 150°; road, azimuth 180°; garden, azimuth 210°; meadow, azimuth 240°; meadow, azimuth 270°; meadow, azimuth 300°; meadow, azimuth 330°. Electromagnetic radiation measurement points at 400 m distance: meadow, azimuth 0°; meadow, azimuth 30°; forest, azimuth 60°; forest, azimuth 90°; forest, azimuth 120°; meadow, azimuth 150°; garden, azimuth 180°; meadow, azimuth 210°; garden, azimuth 240°; meadow, azimuth 270°; by the house, azimuth 300°; by the outhouse, azimuth 330°. Electromagnetic radiation measurement points at 500 m distance: meadow, azimuth 0°; meadow, azimuth 30°; forest, azimuth 60°; forest, azimuth 90°; meadow, azimuth 120°; road, azimuth 150°; meadow, azimuth 180°; meadow, azimuth 210°; garden, azimuth 240°; meadow, azimuth 270°; road, azimuth 300°; meadow, azimuth 330°. Antennas are outside direct visibility in forests and under the trees. The arithmetic mean of 3 values is considered as the test result. The duration of one measurement is 6 minutes.

Antenna effectively only radiate in a sector, see in Figs. 12, 13 and 14.

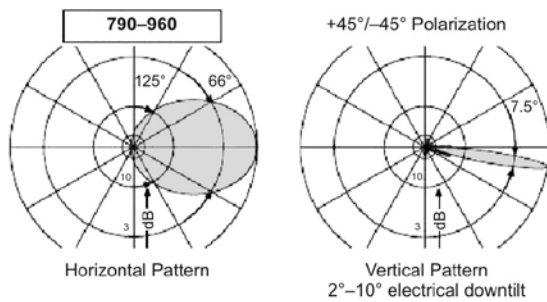

Fig. 12. Horizontal and vertical radiation distribution for 790–960 MHz

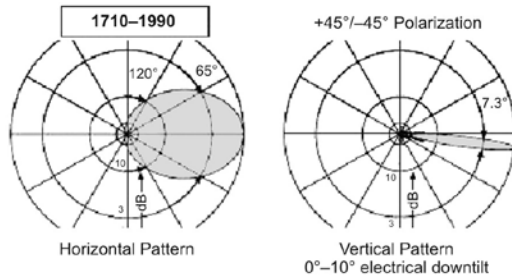

Fig. 13. Horizontal and vertical radiation distribution for 1710–1990 MHz

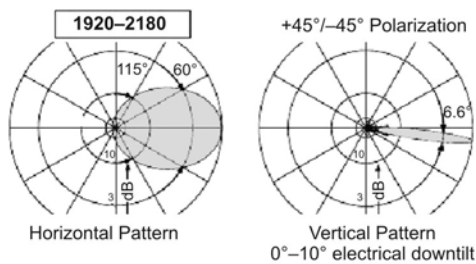

Fig. 14. Horizontal and vertical radiation distribution for 1920–2180 MHz

The tests were carried out with NBM-550 Broadband Field Meter with Probe EF 0392 (E-field, flat) (Fig. 15). It is one of the most accurate measuring instruments for non-ionising radiation. The operating frequency range (100 kHz – 3000 MHz) of NBM Broadband Field Meter with Probe EF 0392, coincides with the operating range of hazardous radiation sources, i.e. mobile communication base stations, antennas and mobile phones.



Fig. 15. NBM-550 Broadband Field Meter with isotropic probe

NBM Broadband Field Meter with isotropic probe specification: electric field intensity is measured from 0.01 V/m, magnetic field strength is measured from 0.01 mA/m, EMF power density is measured from 0.001 mW/m² or 0.1 nW/cm². Dynamic range of the instrument: for electric field strength – 0.01 V/m to 100 kV/m; magnetic field strength – 0.01 mA/m to 250 A/m; EMF power density – 0.001 mW/m² to 25.00 MW/m²; or EMF power density – 0.1 nW/cm² to 2.5 kW/cm².

NBM Broadband Field Meter with isotropic probe ensures special measurement conditions (eliminates by-effects). NBM Broadband Field Meter with isotropic probe is fitted up with quick-acting and automated measuring equipment which depends on the functional and structural solutions of the equipment. The meter is distinguished by high operational speed and is capable of doing 360 measurements per minute. The meter's inertia duration is 0.6 s.

The measurement accuracy of EMFs produced by mobile communication and the data reliability are evaluated through the application of methodologies for calculating measurement uncertainties (Table 1).

Table 1. Error evaluation in EMF measurement for mobile communication antennas

Factors predetermining errors	Expanded uncertainty with 95% level of confidence
NBM 550 with isotropic probe calibration	± 6.4%
Temperature	± 1.5%
Nonlinearity	± 1.8%
Measuring person's influence	± 1.4%
TOTAL	± 11.1%

EMF measurements are characteristic of the fact that the duration of each measurement is the same but measurement conditions differ: ambient temperature, propagation of EMF from the antenna in different directions, i.e. nonlinearity, measuring person's influence. Results are also influenced by a measuring instrument calibration error.

Calibration errors for NBM 550 with isotropic probe are taken from the instrument's certificate of calibration. In the calibration phase, the sensor is immersed in a known value of electric field. This value is obviously associated with an uncertainty, depending strictly on the calibration chain: power meters, generation antennas, anechoic chamber, TEM cells, etc. These levels of uncertainty are the "best measurement capability" of the laboratory and they vary depending on the calibration level and frequency. The influence of temperature and nonlinearity on measurements is evaluated according to the instrument's technical specification. Measuring person's influence is evaluated by doing measurements under identical conditions and safety person's distance from the device (about 10 m).

3. Results and discussion

Evaluation by the HN 80:2011 indicating the exposure of EMF power density in $\mu\text{W}/\text{cm}^2$ (there is no difference between near field or far field situations). Evaluation by the LST EN 50383:2010 indicating that: in the radiative near field, the relationships between the electric and the magnetic fields are much more complex, and separate evaluation of them should be performed; and only at a sufficiently large distance from the source, in the so-called far-field region, it is sufficient to evaluate EML power density in $\mu\text{W}/\text{cm}^2$.

We did separate measurements for the electric field, for the magnetic field and for the EMF power density and compared differences of evaluation. Power density was assessed by the use of E-field probe and internal calculator of NBM-550.

The tests performed (by the LST EN 50492:2009 requirements) on the roof in front of the mobile communication antenna in the near-field revealed the presence of intensive power exchange between the antenna, electric field and magnetic field, which changes rapidly with distance (Fig. 16).

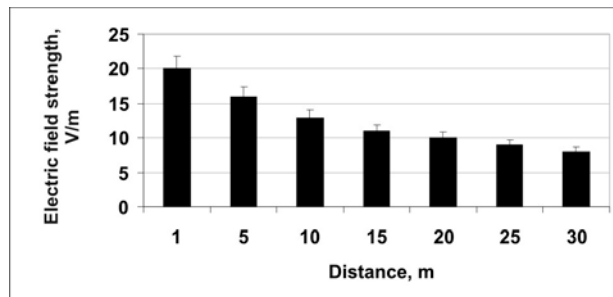

Fig. 16. Electric field strength distribution with bigger distance from the mobile communication antenna

Fig. 16 shows that the electric field strength decreases very rapidly with a distance from the antenna's vertical axis increasing up to 15 metres, but the decrease slows down from 20 m distance. The electric field strength decreases nearly by 2 times, from 20 V/m to 11 V/m. As the distance from the antenna increases to 20 m and above, the electric field strength does not decrease so rapidly any longer ranging from 10 V/m to 8 V/m. The threshold value for electric field strength is not regulated in Lithuania. Other EU states have set different threshold values for electric field strength: the strictest threshold value for electric field strength, 7 V/m, is set in Poland; the maximum threshold value fixed for electric field strength in Austria, Czech Republic, Estonia, Cyprus, Finland, France, Germany, Hungary, Ireland, Malta, Portugal, Romania, Slovakia, Spain, Sweden and the United Kingdom is 61 V/m.

A changing electric field generated by mobile communication creates a magnetic field and therefore the magnetic field shows similar strength decreasing tendencies as the electric field (Fig. 17). At a distance of 1 to 15 metres the magnetic field strength decreased by 1.7 times within a range of 0.05 A/m to 0.03 A/m. With the distance from the mobile communication antenna growing, the magnetic field strength decreased gradually within a

range of 0.028 A/m to 0.02 A/m. The threshold value for magnetic field strength is regulated neither in Lithuania nor in the rest of Europe.

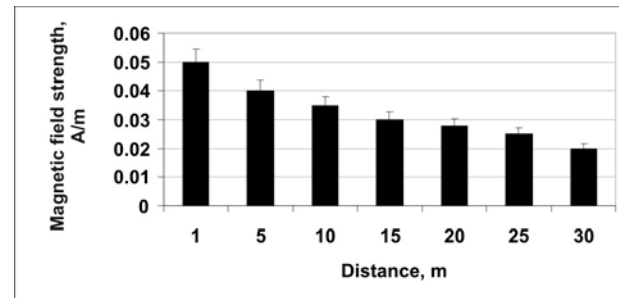

Fig. 17. Magnetic field strength distribution with bigger distance from the mobile communication antenna

The performed tests showed that communication between the electric and magnetic fields and the cellular antenna became much poorer with a bigger distance from the antenna.

Electromagnetic wave (in the far zone) is subject to the following dependence: $E / H = Z_b$; where E and H – vector modules of the strength of both fields of the wave, while Z_b – wave resistance of the space within which wave is travelling. For air $Z_b = 120 \pi \Omega = 377$. As the performed investigations have shown, when a distance from the mobile communication antenna grows, the relation of electrical and magnetic field with the antenna becomes weaker.

During investigations, the electric to magnetic field strength ratio became equal to 377 at a distance of 20 metres from mobile communication. With a distance from the antenna growing the relation of electric to magnetic field strength did not change and equalled 377, which attests to the fact that the formed electromagnetic wave continued spreading (Fig. 18).

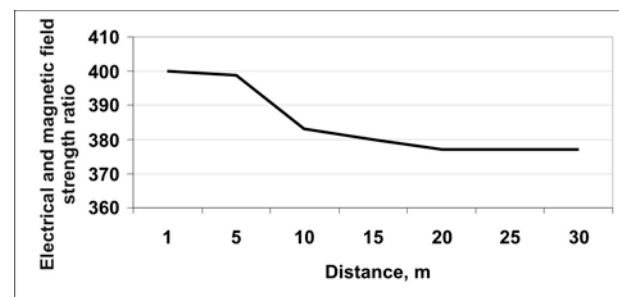

Fig. 18. Relation between the strength of the electrical and the magnetic field when a distance to the mobile communication antenna increases

The power density can be directly measured or calculated based only on measurements of the electric field or the magnetic field, according to the formulas: $S = E^2/377$ or $S = 377 H^2$, where E is the electric field in V/m, H is the magnetic field in A/m and S is the power density in W/m^2 (we are using $\mu\text{W}/\text{cm}^2$).

The tests performed (by the HN 80:2011 requirements) showed that the EMF power density exceeding allowable 10 $\mu\text{W}/\text{cm}^2$ value (Fig. 19). At the 1 m distance from the antenna EMF power density is equal to

111 $\mu\text{W}/\text{cm}^2$ and the authorised value, 10 $\mu\text{W}/\text{cm}^2$, is exceeded by more than 11 times. With a distance from the mobile communication antenna increasing, the EMF power density gradually decreases, but even at 30 metre distance from the antenna it exceeds allowable 10 $\mu\text{W}/\text{cm}^2$ value and reaches 15 $\mu\text{W}/\text{cm}^2$.

Measuring the electric field and magnetic field and using the far-field assumptions in near zone led to overestimating the exposure (Fig. 19). Calculations indicated that using the far-field approximation at 1 m from antenna overestimated the exposure by 20 per cent, at 5 m – by 20 per cent, at 10 m – by 20 per cent, at 15 m – by 25 per cent. And only at 20 m the electric and magnetic fields became related, and were sufficient to evaluate only one of them.

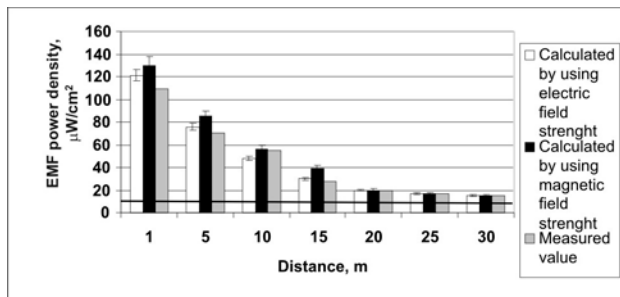

Fig. 19. Calculated EMF values based on measurements of the electric field and the magnetic field (permissible level – 10 $\mu\text{W}/\text{cm}^2$)

The tests conducted in the direction of the most intensive radiation from the antenna at a height of 1.5 m above the ground showed that the EMF power density started increasing with a growing distance from the antenna, created the local maximum at a certain distance and subsequently started decreasing.

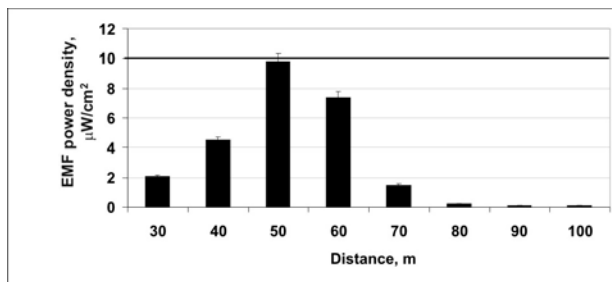

Fig. 20. EMF power density distribution on the ground with bigger distance from the antenna (permissible level – 10 $\mu\text{W}/\text{cm}^2$)

At a distance of 30 m from the antenna’s vertical axis the EMF power density value created by the mobile communication antenna at a height of 1.5 m above the ground is 2.1 $\mu\text{W}/\text{cm}^2$ but it is not real value because of shadowing. The shadowing effects characterise the blocking of the EMF power density propagation by house’s wall. At a distance of 40 m from the antenna’s vertical axis the EMF power density value created by the mobile communication antenna at a height of 1.5 m above the ground is 4.5 $\mu\text{W}/\text{cm}^2$, and 50 m – 9.8 $\mu\text{W}/\text{cm}^2$ (Fig. 20). At 50 m distance from the antenna the EMF power density value still does not exceed the maximum permissible level (10 $\mu\text{W}/\text{cm}^2$) but nearly equals it. The test measurements showed that antenna’s pattern on the vertical

plane had a quite narrow lobe directed downwards (Fig. 17). Consequently, the highest power density value is in the place where the main lobe of antenna’s diagram reaches the ground, i.e. at 50 m distance from the antenna. With yet bigger distance from the antenna the EMF power density starts decreasing: at 60 m distance it reaches 7.4 $\mu\text{W}/\text{cm}^2$, at 70 m – 1.5 $\mu\text{W}/\text{cm}^2$, at 80 m – 0.23 $\mu\text{W}/\text{cm}^2$, at 90 m – 0.11 $\mu\text{W}/\text{cm}^2$, at 100 m – 0.1 $\mu\text{W}/\text{cm}^2$. At a distance of above 100 m the EMF power density changes insignificantly varying within intervals between 0.01 $\mu\text{W}/\text{cm}^2$ and 0,1 $\mu\text{W}/\text{cm}^2$. The mobile communication antenna creates only one maximum in the maximum radiation direction and with a distance from the antenna growing, the EMF power density decreases in inverse proportion to the square of the distance from the antenna’s geometrical centre to the test point in space. With bigger distances, where interference occurs due to reflections from buildings and relief conditions, the EMF power density decreases even more and is much related to terrain properties.

Fig. 21 shows the results of measurements at 1.5 m height above the building roof which is in the closest proximity to the mobile communication antenna within antenna’s direct visibility area. It is obvious that the EMF power density gradually decreases in the direct visibility area with the distance from the antenna’s vertical axis increasing. At 35 m distance from the antenna’s vertical axis the EMF density value represents 87% of the permissible level (10 $\mu\text{W}/\text{cm}^2$), at 40 m – 73%, 45 m – 53%, 50 m – 49%, 55 m – 20%, 60 m – 16%, 65 m – 10%, and 70 m – 5%. The presented results show that the permissible value is not exceeded, and the power density of antenna’s main pattern lobe on the horizontal plane decreases according to the square dependence in the immediate area of the antenna.

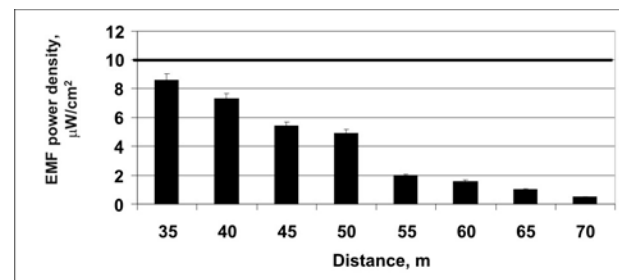

Fig. 21. Distribution of EMF power density values in the immediate area of the antenna on the roof (permissible level – 10 $\mu\text{W}/\text{cm}^2$)

Distribution of the EMF maximum power density produced by the mobile communication directional antenna vs time is presented in Fig. 12. The conducted tests showed that the EMF maximum power density created by the mobile communication antenna was not stable and was largely dependent on the time of the day (Fig. 19). This is particularly noticeable in the direction of the most intensive radiation at 1.5 m height above the ground and at 50 m distance from the antenna’s vertical axis as the EMF maximum power density radiated in this area is high enough. Fig. 22 shows that the highest value of the EMF power density, 9.8 $\mu\text{W}/\text{cm}^2$, was recorded in the daytime at 16:00; the

other maximum power density values vary from $9.0 \mu\text{W}/\text{cm}^2$ to $9.6 \mu\text{W}/\text{cm}^2$. The reason for that is that the control channels of mobile communication antenna continually transmit uniform power which does not depend on the flow of information transmitted. Other channels transmit information only when necessary and their power can be regulated. Due to this the EMF power density radiated by the antenna may change in the course of the day or week depending on the number of additional communication information channels. The EMF power density radiated by an antenna with several channels depends on the number of channels in use, the number of time intervals used and other factors. At 100 metre distance from the antenna's vertical axis the EMF maximum power density changes very insignificantly, from $0.45 \mu\text{W}/\text{cm}^2$ to $0.58 \mu\text{W}/\text{cm}^2$. At 100 m and bigger distance from the antenna's pole axis the EMF maximum power density decreases by around 100 times and more (as against 50 m distance) distributing evenly at 1.5 m height above the ground and becomes independent from antenna-radiated power. In this case the change of EMF power density depends on relief conditions, buildings, trees and is much more complicated due to reflections, absorption interference, etc.

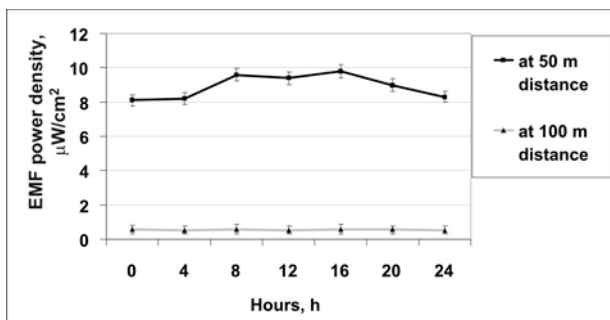

Fig. 22. Distribution of EMF maximum power density values vs time

Distribution of the EMF power density produced by the mobile communication directional antenna at different height in a balcony is presented in Fig. 16. The performed tests on EMF power density in a balcony in front of the mobile communication antenna showed the highest values to be on floors 5 to 8. Antenna's directionality appears at 35 m distance from the mobile communication antenna on the vertical plane forming the main coverage area of 20 m which includes floors 5, 6, 7 and 8 (Fig. 23). At 35 m distance from the antenna's vertical axis the value of the EMF power density produced by the mobile communication antenna at 1.5 height above the floor in a balcony on floor 5 is $6.8 \mu\text{W}/\text{cm}^2$, on floor 6 – $7.5 \mu\text{W}/\text{cm}^2$, floor 7 – $7.1 \mu\text{W}/\text{cm}^2$, floor 8 – $5.5 \mu\text{W}/\text{cm}^2$. The mobile communication antenna is on the same plane as floor 6 and, in addition, the antenna's azimuth coincides with floor 6 and therefore the EMF power density values are the highest in the direction of the most intensive radiation.

Tests performed inside a room at 0.5 m, 1.0 m and 1.7 m heights (1 m distance from the window) showed that plastic frame windows effectively shielded electromagnetic radiation (Fig. 24). At closed windows EMF power density values fell around 10 times on all floors

compare with the values in a balcony. Window glass coated with a very thin and almost invisible layer of metal and metal oxides shields electromagnetic radiation and reflects electromagnetic radiation to the outside.

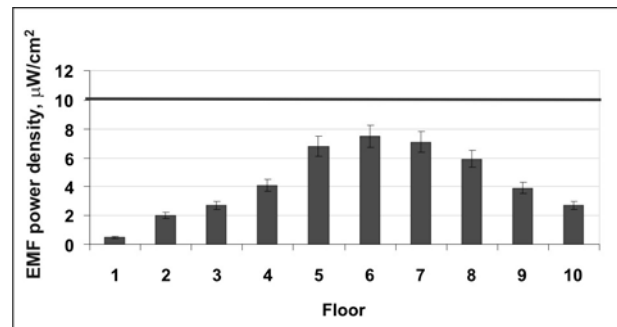

Fig. 23. Distribution (in a balcony) by height of antenna-radiated EMF power density (permissible level – $10 \mu\text{W}/\text{cm}^2$)

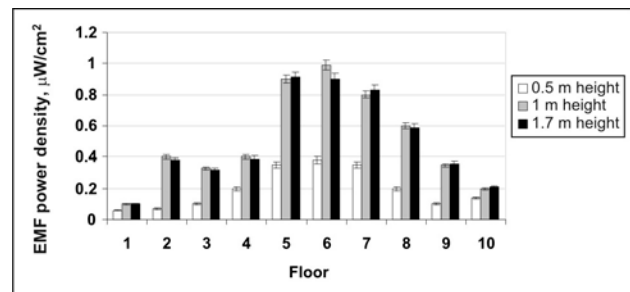

Fig. 24. Distribution in room (1 m distance from the window) by height of antenna-radiated EMF power density

When measuring EMF power density emitted by antenna in a room, large variations may be observed in the resulting exposure levels even within small variations in a height (e.g. within a 0,5 meter) (Fig. 25). This is due to the existence of various propagation paths (reflections, diffractions and line of sight propagation). The resulting variations, which in principle are due to the presence of other objects (room wall etc.), can be described by fast fading and shadowing.

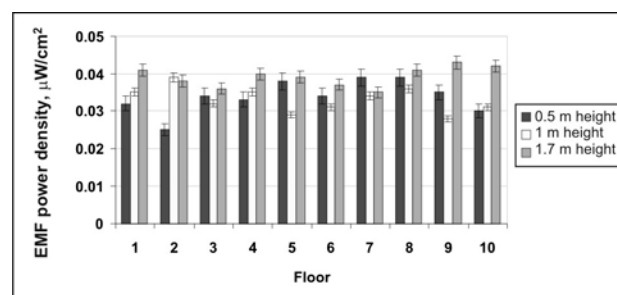

Fig. 25. Distribution in a middle of the room by height of antenna-radiated EMF power density

Figs. 26 to 27 present the results of measurements at different distances at 1.5 m height above the ground around 4 mobile communication antennas. The tests carried out in a rural area in front of mobile communication antennas on a 70 m high pole revealed low values of EMF power density which did not exceed the permissible level ($10 \mu\text{W}/\text{cm}^2$).

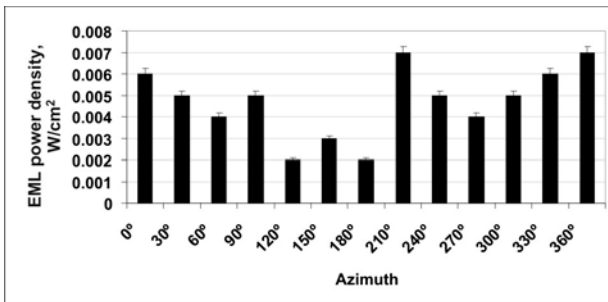

Fig. 26. EMF power density values around the mobile communication antenna at 50 m distance, at 1.5 m height (permissible level – $10 \mu\text{W}/\text{cm}^2$)

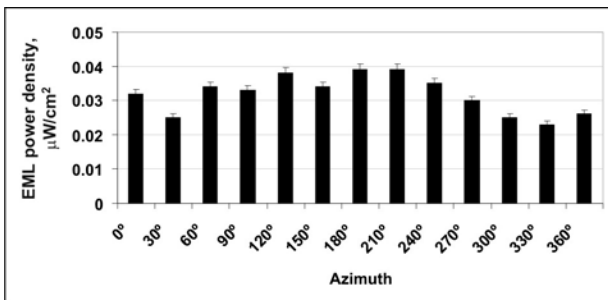

Fig. 27. EMF power density values around the mobile communication antenna at 100 m distance, at 1.5 m height (permissible level – $10 \mu\text{W}/\text{cm}^2$)

EMF power density values around the mobile communication pole with 4 antennas mounted on it at 50 m distance, and at 1.5 m height above the ground are not above $0.007 \mu\text{W}/\text{cm}^2$; the others are within intervals from $0.002 \mu\text{W}/\text{cm}^2$ to $0.006 \mu\text{W}/\text{cm}^2$ (Fig. 26). The values of EMF power density in the measurement points beside 90° 120° 150° azimuths are by 2 to 3 times lower as these points are within antenna's indirect visibility area, i.e. under the trees. EMF power density values under the base station antenna are very low as the main radiation lobe of the antenna reaches the ground at a distance of around 100 m to 200 m. Consequently, concerns that EMF power density values are the highest next to the base station tower are ungrounded.

Fig. 27 shows that at a distance of 100 m from the antenna the EMF power density does not exceed 0.3% – 0.4% of the permissible level ($10 \mu\text{W}/\text{cm}^2$). Compared with 50 m distance, the level of EMF intensity increased by 10 times. At 200 m distance the power density values of the electromagnetic field produced by the mobile communication antenna represents 0.4% of the permissible level value ($10 \mu\text{W}/\text{cm}^2$). Compared with 100 m distance, the EMF intensity level is very similar. At 300 m distance and at 1.5 m height above the ground do not go above $0.05 \mu\text{W}/\text{cm}^2$; the remaining ones are scattered within intervals from $0.01 \mu\text{W}/\text{cm}^2$ to $0.045 \mu\text{W}/\text{cm}^2$. At 400 m and 500 m distance and at 1.5 m height above the ground EMF power density values are scattered within intervals from $0.012 \mu\text{W}/\text{cm}^2$ to $0.043 \mu\text{W}/\text{cm}^2$.

It is very important to make the widest possible signal coverage area in the terrain under testing and EMF power density values, therefore, are so low. In this case high gain antennas (17 dBi) mounted on a tall pole (70 m) are used. Such antennas have very small radiation diagram

lobes, a narrow angle of the vertical directional pattern and a wide distribution of the EMF power density on the horizontal plane. This was confirmed by very low values obtained from the performed measurements of EMF power density on the ground at 50 m, 100 m, 200 m, 300 m, 400 m, and 500 m distances from the base station which are scattered within intervals from $0.002 \mu\text{W}/\text{cm}^2$ to $0.05 \mu\text{W}/\text{cm}^2$ and they are by up to 500 times below the values permissible by HN 80:2011. Furthermore, the values of EMF power density decrease according to the square dependence in the free space, while at bigger distances where interference is most frequent due to reflections from buildings and relief roughness the EMF power density decreases even more rapidly.

In addition, low EMF power density values are predetermined by mobile communication antenna manufacturers. They develop antenna directional patterns so that the most even distribution possible is achieved at 1.5 m height above the ground as the distance from the pole axis of the mobile communication antenna increases, i.e. approximately at the height we use our mobile phones.

4. Conclusions

1. In conclusion, it can be stated that there are variations between measurements requirements given in different international documents. The main reasons for this variation appear to be differences in the protection concepts used in different countries. The tests performed (by the LST EN 50383:2010 requirements) on the roof in front of the mobile communication antenna in the near-field revealed the presence of intensive power exchange between the antenna, electric field and magnetic field, which changes rapidly with distance. The electric field strength decreases nearly 2.5 times, from 20 V/m to 8 V/m. The magnetic field strength decreased 2.5 times as well within a range of 0.05 A/m to 0.02 A/m. The tests performed (by the HN 80:2011 requirements) showed that the EMF power density exceeding allowable $10 \mu\text{W}/\text{cm}^2$ value. At the 1 m distance from the antenna EMF power density is equal to $111 \mu\text{W}/\text{cm}^2$ and the authorised value, $10 \mu\text{W}/\text{cm}^2$, is exceeded more than 11 times. With a distance from the mobile communication antenna increasing, the EMF power density gradually decreases, but even at 30 metre distance from the antenna it exceeds allowable $10 \mu\text{W}/\text{cm}^2$ value and reaches $15 \mu\text{W}/\text{cm}^2$.

2. The mobile communication antenna (in Šeškinės street 2) creates the maximum in the most intensive radiation direction. The highest EMF power density value, $9.8 \mu\text{W}/\text{cm}^2$, was recorded on the ground at 50 m distance from the antenna. With distance the EMF power density starts decreasing in inverse proportion to the square of the distance from the antenna's geometrical centre to the test point in space: at 60 m distance it reaches $7.4 \mu\text{W}/\text{cm}^2$, at 70 m – $1.5 \mu\text{W}/\text{cm}^2$, 80 m – $0.23 \mu\text{W}/\text{cm}^2$, 90 m – $0.11 \mu\text{W}/\text{cm}^2$, 100 m – $0.1 \mu\text{W}/\text{cm}^2$.

3. With the distance from the antenna's vertical axis within the direct visibility (in Kauno street 5) area increasing the EMF power density gradually falls to 2 to $3 \mu\text{W}/\text{cm}^2$. At 35 m distance from the antenna's vertical axis the EMF density value represents 87% , at 40 m –

73%, 45 m – 53%, 50 m – 49%, 55 m – 20%, 60 m – 16%, 65 m – 10%, and 70 m – 5% of the permissible level ($10 \mu\text{W}/\text{cm}^2$).

4. The EMF maximum power density produced by the mobile communication antenna is not stable and is largely dependent on the time of the day. This is in particular noticeable at 50 m distance from the antenna, as quite high EMF maximum power density (about $9 \mu\text{W}/\text{cm}^2$) is radiated in this area. The highest EMF power density was recorded at 8:00 and 16:00 reaching $9.6 \mu\text{W}/\text{cm}^2$ and $9.8 \mu\text{W}/\text{cm}^2$, respectively.

5. Distribution of the EMF power density produced by the mobile communication antenna (in Rugių street 4) is largely dependent on the antenna's directional pattern on the vertical plane. EMF power density values are the highest in the balconies that are within the main coverage area of the antenna. The conducted tests showed that the main coverage area of the mobile communication antenna was within 20 metres and included floors 5, 6, 7 and 8. On floor 5, the power density reaches $6.8 \mu\text{W}/\text{cm}^2$, on floor 6 – $7.5 \mu\text{W}/\text{cm}^2$, on floor 7 – $7.1 \mu\text{W}/\text{cm}^2$, on floor 8 – $5.5 \mu\text{W}/\text{cm}^2$. Electromagnetic radiation is effectively shielded (by up to 10 times) by window glass coated with a very thin and almost invisible layer of metals and metal oxides that reflects electromagnetic radiation to the outside.

6. The mobile communication antennas used in rural areas (Lavoriškės) are characteristic of very small side lobes of their directional pattern, a narrow angle of the vertical directional pattern and a wide distribution of the EMF power density on the horizontal plane at 1.5 m height above the ground, i.e. at nearly the same height we use mobile phones. Consequently, the EMF power density values on the ground at 50 m, 100 m, 200 m, 300 m, 400 m, and 500 m distance from the base station in rural areas are very low, scattered within intervals from $0.002 \mu\text{W}/\text{cm}^2$ to $0.05 \mu\text{W}/\text{cm}^2$.

References

- Akbal, A.; Kiran, Y.; Sahin, A.; Turgut-Balik, D.; Balik, H. 2012. Effects of electromagnetic waves emitted by mobile phones on germination, root growth, and root tip cell mitotic division of *Lens culinaris medik*, *Polish Journal of Environmental Studies* 21(1): 23–29.
- Alanko, T.; Hietanen, M.; von Nandelstadh, P. 2008. Occupational exposure to RF fields from base station antennas on rooftops, *Annals of Telecommunications* 63: 125–132. <http://dx.doi.org/10.1007/s12243-007-0001-6>
- Alanko, T.; Hietanen, M. 2007. Occupational exposure to RF fields in antenna towers, *Radiation Protection Dosimetry* 123: 537–539. <http://dx.doi.org/10.1093/rpd/nc1505>
- Baltrėnas, P.; Buckus, R. 2011. Research and assessment safety distance of tv electromagnetic fields, *International Journal of Occupational Safety and Ergonomics* 17(1): 33–39.
- Baltrėnas, P.; Buckus, R.; Vasarevičius, S. 2011. Modelling of the Computer classroom electromagnetic field, *Elektronika ir elektrotechnika* 109(3): 75–80.
- Baltrėnas, P.; Buckus, R. 2009. Kopijavimo aparatų elektromagnetinių laukų tyrimai ir įvertinimas [The exploration and assessment of electromagnetic fields in duplicators.], *Journal of Environmental Engineering and Landscape Management* 2(17): 89–96. <http://dx.doi.org/10.3846/1648-6897.2009.17.89-96>
- Bernardi, P.; Cavagnaro, M.; Pisa, S.; Piuze, E. 2000. Human exposure to radio base-station antennas in urban environment, *IEEE Transactions on Microwave Theory and Techniques* 48(11): 1996–2002. <http://dx.doi.org/10.1109/22.884188>
- Bergqvist, U.; Friedrich, G.; Hamnerius, Y.; Martens, L.; Neubauer, G.; Thuroczy, G.; Vogel, E.; Wiart, J. 2001. *Mobile telecommunication base stations - exposure to electromagnetic fields* [online], Report of a Short Term Mission within COST 244bis [cited 12 January 2011]. Available from Internet: www.cost281.org.
- Cicchetti, R.; Faraone, A.; Balzano, Q. 2003. A uniform asymptotic evaluation of the field radiated from collinear array antennas, *IEEE Transaction on Antennas and Propagation* 51(1): 89–102. <http://dx.doi.org/10.1109/TAP.2003.808540>
- Damian, C.; Foşalău, C. 2011. Sources of indoor noise and options to minimize adverse human health effects, *Environmental Engineering and Management Journal* 10(3): 393–400.
- Dolan, M.; Rowley, J. 2009. The precautionary principle in the context of mobile phone and base station radio frequency exposures, *Environmental Health Perspectives* 117: 1329–1332. <http://dx.doi.org/10.1289/ehp.0900727>
- Henderson, S. I.; Bangay, M. J. 2006. Survey of exposure levels from mobile telephone base stations in Australia, *Bioelectromagnetics* 27: 73–76. <http://dx.doi.org/10.1002/bem.20174>
- Lin, J. C. 2002. Cellular mobile telephones and children, *IEEE Antennas and Propagation Magazine* 44(5): 142–145. <http://dx.doi.org/10.1109/MAP.2002.1077792>
- Loughran, S. P.; Wood, A. W.; Barton, J. M.; Croft, R. J.; Thompson, B.; Stough, C. 2005. The effect of electromagnetic fields emitted by mobile phones on human sleep, *Neuroreport* 16: 1973–1976. <http://dx.doi.org/10.1097/01.wnr.0000186593.79705.3c>
- Mangoud, M. A.; Abd-Alhameed, R. A.; Excell, P. S. 2000. Simulation of human interaction with mobile telephones using hybrid techniques over coupled domains, *IEEE Transactions on Microwave Theory and Techniques* 48(11): 2014–2021. <http://dx.doi.org/10.1109/22.884190>
- Miclaus, S.; Bechet, P. 2007. Estimated and measured values of the radiofrequency radiation power density around cellular base stations, *Romanian Journal of Physics* 52(3–4): 399–409.
- Olivier, C.; Martens, L. 2005. Optimal settings for narrow-band signal measurements used for exposure assessment around GSM base stations, *IEEE Transactions on Instrumentation and Measurement* 54(1): 311–317. <http://dx.doi.org/10.1109/TIM.2004.838114>
- Pocius, R. 2005. Antenų kryptingumo diagramų nuosvyrio įtaka formuojant mobiliojo korinio ryšio ląstelių ribas ir vertinant elektromagnetinio lauko intensyvumą [The Influence of Downtilt of Antennae Directional Diagrams on the Formation of Mobile Network Cells and Estimation of Electromagnetic Field Intensity], *Elektronika ir elektrotechnika* 64: 31–36.
- Poljak, D.; Kovac, N. 2004. A simplified electromagnetic-thermal analysis of human exposure to radiation from base station antennas, *Automatika* 45(1): 11–17. <http://dx.doi.org/10.1016/j.enganabound.2004.02.004>
- Santini, R.; Santini, P.; Le Ruz, P.; Danze, J. M.; Seigne, M. 2003. Survey study of people living in the vicinity of cellular phone base stations, *Electromagnetic Biology and Medicine* 22: 41–49. <http://dx.doi.org/10.1081/JBC-120020353>

MOBILIOJO RYŠIO ANTENŲ ELEKTROMAGNETINIŲ LAUKŲ INTENSYVUMO PARAMETRŲ TYRIMAI IR VERTINIMAS

P. Baltrėnas, R. Buckus, S. Vasarevičius

Santrauka

Pastaruoju metu paplitus koriniam mobiliųjų telefonų tinklui ir ypač – įvedus skaitmenines GSM 900/1800/2100 sistemas, daugelyje Europos šalių pradėta rūpintis dėl galimo šių sistemų bazinių stočių elektromagnetinės spinduliuotės poveikio žmogaus sveikatai. Kai kuriose šalyse imta reikalauti zonų be mobiliųjų telefonų, kuriose būtų draudžiama įrengti bazines stotis, gerokai sumažinti didžiausiąją leidžiamąją apšvitą ar įvesti kitus ribojimus. 1999 m. liepos 12 d. priimta Europos Tarybos rekomendacija nurodo nustatyti maksimalių elektromagnetinės spinduliuotės (0–300 GHz) laukų stiprį, reikalauja teikti informaciją apie gyventojų apšvitą dėl elektromagnetinių laukų bei taikomas priemones jai sumažinti. Pateikiami ir nagrinėjami gyvenamojoje zonoje mobiliojo ryšio antenų sukurtų elektromagnetinių laukų duomenys. Atlikti elektrinio stiprio, magnetinio stiprio ir elektromagnetinio lauko energijos srauto tankio matavimai. Duomenys lyginami su nustatytomis higienos normomis. Tyrimai atlikti artimojoje ir tolumojoje antenos zonoje, gyvenamosiose patalpose, esančiose prieš anteną. Mobiliojo ryšio elektromagnetinių laukų matavimai atlikti ir kaimo vietovėse.

Reikšminiai žodžiai: elektrinio lauko stipris, magnetinio lauko stipris, elektromagnetinio lauko energijos srauto tankis, mobiliojo ryšio antena.

Pranas BALTRĖNAS. Dr Habil, Prof and Head of Dept of Environmental Protection, Vilnius Gediminas Technical University (VGTU). Doctor Habil of Science (Air Pollution), Leningrad Civil Engineering Institute (Russia), 1989. Doctor of Science (Air Pollution) Ivanov Textile Institute (Russia), 1975. Employment: Professor (1990), Associate Professor (1985), senior lecturer (1975), Vilnius Civil Engineering Institute (VISI, now VGTU). Publications: author of 13 monographs, 24 study-guides, over 320 research papers and 67 inventions. Honorary awards and membership: prize-winner of the Republic of Lithuania (1994), a corresponding Member of the Ukrainian Academy of Technological Cybernetics, a full Member of International Academy of Ecology and Life Protection. Probation in Germany and Finland. Research interests: air pollution, pollutant properties, pollution control equipment and methods.

Raimondas BUCKUS. Graduate student (environmental protection engineering) at Dept of Environmental Protection, Vilnius Gediminas Technical University (VGTU). Master of Science (Environmental Engineering), VGTU, 2009. Bachelor of Science (Applied Ecology), ŠU, 2007. Publications: author of research paper. Research interests: electromagnetic fields, electromagnetic radiation.

Saulius VASAREVIČIUS. Dr, Assoc. Prof. (since 2003), Dept of Environmental Protection, Vilnius Gediminas Technical University (VGTU). Doctor of Science (Environmental Engineering), VTU (now VGTU), 1995. Master of Science, VTU (now VGTU), 1991. First degree in Civil Engineering and Management, Vilnius Civil Engineering Institute (VISI, now VGTU), 1989. Publications: author of more than 40 research papers and monographs. Probation in Germany. Research interests: environmental management, air pollution, soil pollution, waste management.